

Article number: 20908STM1415A

Description: E+G Threaded plug DIN 908-ST-M14x15-A

## Measures

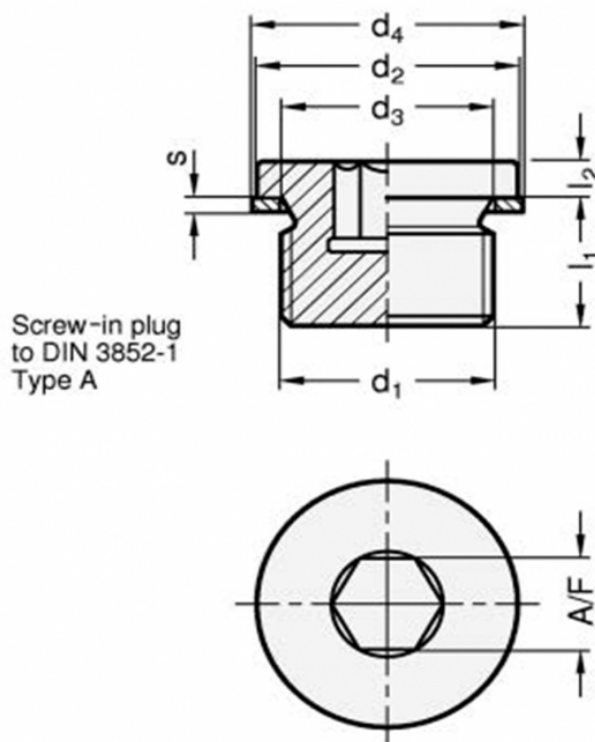

A/F	= 6
d1	= M14x15
d2h14	= 19
d3	= 14.3
d4	= 18
l1	= 12
l2	= 3
s	= 1.5

Weight in (g) = 16